



## KR 6 R700-2



### Technical data

Maximum reach	726 mm
Maximum payload	6.8 kg
Pose repeatability (ISO 9283)	± 0.02 mm
Number of axes	6
Mounting position	Floor; Ceiling; Wall; Desired angle
Footprint	208 mm x 208 mm
Weight	approx. 53 kg

### Axis data

Motion range	
A1	±170 °
A2	-190 ° / 45 °
A3	-120 ° / 156 °
A4	±185 °
A5	±120 °
A6	±350 °

### Operating conditions

Ambient temperature during operation	0 °C to 45 °C (273 K to 318 K)
--------------------------------------	--------------------------------

### Protection rating

Protection rating (IEC 60529)	IP65 / IP67
Protection rating, robot wrist (IEC 60529)	IP65 / IP67

### Controller

Controller	KR C5 micro; KR C4 compact
------------	-------------------------------

### Certificates

ESD requirements	IEC61340-5-1; ANSI/ESD S20.20
------------------	-------------------------------

### Teach pendant

Teach pendant	KUKA smartPAD
---------------	---------------

### Cycle time

138 cycles per minute (25 mm / 305 mm / 25 mm, 1 kg)



### Workspace graphic

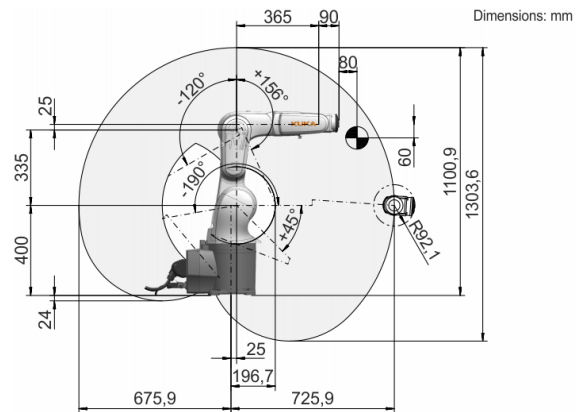

### Payload diagram

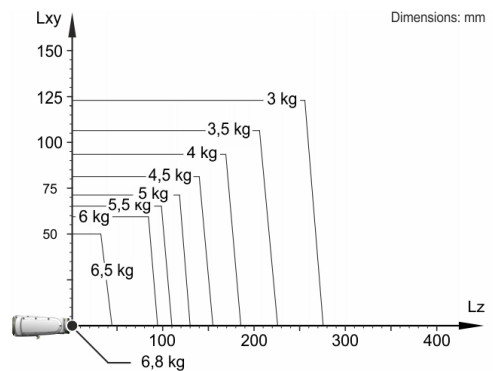

The KR 6 R700-2 is designed for a rated payload of 3 kg in order to optimize the dynamic performance of the robot. With reduced load center distances, higher loads up to the maximum payload may be used. The specific load case must be verified using KUKA.Load. For further consultation, please contact KUKA Support.

### Mounting flange

