



KR 6 R1820 HP



Technical data

Maximum reach	1820 mm
Maximum payload	-
Rated payload	6 kg
Rated supplementary load, rotating column / link arm / arm	0 kg / 0 kg / 10 kg
Pose repeatability (ISO 9283)	± 0.04 mm
Number of axes	6
Mounting position	Floor; Ceiling; Wall; Desired angle
Footprint	333.5 mm x 307 mm
Weight	approx. 168 kg

Axis data

Motion range	
A1	±170 °
A2	-185 ° / 65 °
A3	-137 ° / 163 °
A4	±185 °
A5	±120 °
A6	±350 °
Speed with rated payload	
A1	220 °/s
A2	210 °/s
A3	270 °/s
A4	381 °/s
A5	311 °/s
A6	492 °/s

Operating conditions

Ambient temperature during operation	5 °C to 45 °C (278 K to 318 K)
--------------------------------------	--------------------------------

Protection rating

Protection rating (IEC 60529)	IP65
Protection rating, in-line wrist (IEC 60529)	IP67

Controller

Controller	KR C4 smallsize-2; KR C4 compact
------------	-------------------------------------

Teach pendant

Teach pendant	KUKA smartPAD
---------------	---------------

Workspace graphic

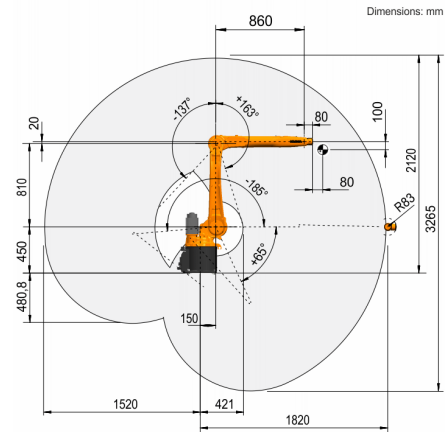

Payload diagram

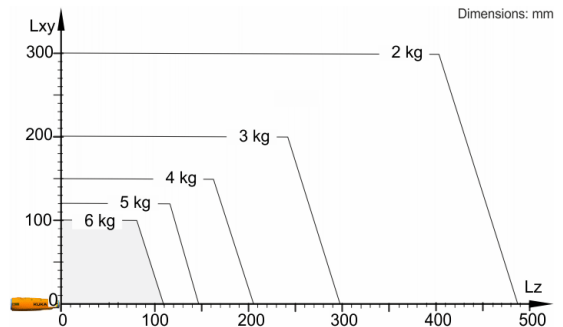

The KR 6 R1820 HP is designed for a rated payload of 6 kg in order to optimize the dynamic performance of the robot. With reduced load center distances, higher loads up to the maximum payload may be used. The specific load case must be verified using KUKA.Load. For further consultation, please contact KUKA Support.

Mounting flange

